

Car No :

University :

CV	EV
Engine (Manufacturer/ Model) : Bore/Stroke :     mm /     mm Fuel Type : 98 ETC : ABS : Yes / No	TS Voltage :         V Body Protection R :     k $\Omega$

MECH 0 (PRE INSPECTION)				
Instruct the teams to prepare all the required equipment and have it ready for inspection. Do not spend your time waiting for unprepared teams.				
TIRES				
No.	Checkpoint	Rule No	Checkbox	Comments
1	<b>DRY TIRES</b>	T2.6		
	<i>Comments and Guidelines:</i> Check tires for damage and extensive, unsafe wear			
	• Make:			
	• Size:			
	• Compound:			
	• MARK TIRES WITH MARKER (to prevent tire change)			
2	<b>RAIN TIRES</b>	T2.6		
	• Make:			
	• Size:			
	• Compound:			
	• Tread depth (+2.4 mm):			
	• MARK TIRES WITH MARKER (to prevent tire change)			
3	Expiration date not passed			
DRIVER GEAR				
No.	Checkpoint	Rule No	Checkbox	Comments
	<i>Comments and Guidelines:</i> Every piece of the drivers equipment shall be checked individually and must be in good condition. Holes, tears, torn stitching, cracks or damage (helmets) are relevant examples. (Also check T13.3.10) Fire resistant material is defined in T13.3.11 as such: <b>T13.3.11</b> For the purpose of this section some, but not all, of the approved fire resistant materials are: Carbon X, Indura, Nomex, Polybenzimidazole (commonly known as PBI) and Proban.			
3	<b>HELMET (x2):</b> Fully Closed Integral Type A well-fitting, closed face helmet that meets one of the following certifications and is labeled as such: • Snell K2010, K2015, K2020, M2010, M2015, M2020, SA2010, SAH2010, SA2015, SA2020, EA2016 or newer • SFI 31.1/2010, 31.1/2015, 31.1/2020, 41.1/2010, 41.1/2015, 41.1/2020 or newer FIA 8860-2010, FIA 8860-2018, FIA 8859-2015 (with SA 2015), FIA 8858-2010 (with SA(H) 2010) or newer • Open faced helmets and off-road helmets (helmets without integrated eye shields) are not approved. • British Standards Institution BS 6658-85 Type A/FR rating (Types A and B are not accepted) <i>All helmets to be used in the competition must be presented during technical inspection where approved helmets will be stickered.</i>	T13.3.2		
4	<b>BALACLAVAS (x2)</b> Made from fire resistant material (as defined in T13.3.11)	T13.3.3		
5	<b>DRIVING SUIT (x2)</b> A fire resistant one piece suit, made from a minimum of two layers that covers the body from the neck down to the ankles and the wrists. The suit must be certified to one of the following standards and be labeled as such: • SFI 3.2A/5 (or higher) • SFI 3.4/5 (or higher) • FIA Standard 8856-2000 • FIA Standard 8856-2018	T13.3.4		
6	<b>FIRE RESISTANT UNDERWEAR (x2)</b> (long pants and long sleeve t-shirt).	T13.3.5		
7	<b>FIRE RESISTANT SOCKS (x2)</b> Made from acceptable fire resistant material as defined in T 13.3.11, that cover the bare skin between the driver's suit and the boots or shoes.	T13.3.6		
8	<b>SHOES (2 pairs)</b> Certified with one of the following: • SFI Spec 3.3 • FIA Standard 8856-2000 • FIA Standard 8856-2018	T13.3.7		

9	<b>GLOVES (2 pairs)</b> Made from acceptable fire resistant material as defined in T 13.3.11. Gloves of all leather construction or fire resistant gloves constructed using leather palms with no insulating fire resisting material underneath are not acceptable.	T13.3.8		
10	<b>ARM RESTRAINTS (x2)</b> Required and must be worn such that the driver can release them and exit the vehicle unassisted regardless of the vehicle's position. Arm restraints must be commercially manufactured according to SFI Standard 3.3 or equivalent. - Certified with one of the following: • SFI Spec 3.3 • FIA Standard 8856-2000 • FIA Standard 8856-2018	T13.3.9		
11	<b>CONDITION STANDARDS</b> All driver equipment covered in T13.3: must be in good condition. Specifically, it must not have any tears, rips, open seams, areas of significant wear or abrasion or stains which might compromise fire resistant performance. The officials reserve the right to impound all non-approved driver equipment until the end of the competition.	T13.3.10		
<b>SAFETY EQUIPMENT</b>				
No.	Checkpoint	Rule No	Checkbox	Comments
	<b>FIRE EXTINGUISHERS (x2)</b>			
12	Dry chemical/dry powder fire extinguishers with a minimum firefighting agent capacity of 0.9 kg, larger capacity are acceptable.	T13.4.1		
13	The following are the minimum accepted ratings: • USA, Canada and Brazil: 10BC or 1A 10BC • Europe: 34B or 5A 34B • Australia: 20BE or 1A 10BE	T13.4.2		
14	Aqueous Film Forming Foam (AFFF) fire extinguishers are prohibited. Halon extinguishers and systems are prohibited.	T13.4.3		
15	All extinguishers must be equipped with a manufacturer installed pressure/charge gauge. • pressure on GREEN • not expired	T13.4.4		
<b>APPROVAL STATUS</b>			<a href="#">gid=0</a>	
MECH0	Approval (Control box) (DON'T CHANGE MANUALLY)		ONWAA R	

MECH 1 - READY TO RACE STATE WITH TALLEST DRIVER				
The teams shall start M1 with the <u>tallest</u> driver inside and securely strapped in a ready to race state.				
<b>!ONLY FOR CV! NO FUEL IN THE FUEL TANK ! IF YES, EMPTY AT THE PIT</b>				
<b>!ONLY FOR EV! CHECK IF THE TEAM HAS BOTH E STICKERS! IF NOT THE ACCUMULATOR MUST NOT BE PRESENT!</b>				
VEHICLE EQUIPMENT				
No.	Checkpoint	Rule No	Checkbox	Comments
16	<b>PUSH BAR</b> <ul style="list-style-type: none"> <li>Colored red</li> <li>Clearly visible UNI name written on a high contrast background</li> <li>Push bar handle behind rear axle</li> <li>Fire extinguisher easily accessible</li> <li>HV gloves protected in a box, 2 pairs (EV Only)</li> <li>Multimeter (EV Only)</li> <li>4mm banana plug test lead (EV only)</li> </ul>	T13.1		
17	<b>JACK</b> <ul style="list-style-type: none"> <li>One or two removable devices (jacks) that hold the vehicle, so that all <b>driven</b> wheels are at least 100mm off the ground</li> <li>Safe positioning of the device (not reaching under the vehicle)</li> <li>Vehicle is adequately supported</li> <li>In the lifted position the vehicle must stand securely and stable</li> <li>It must be safe for a driver to enter and exit the vehicle</li> <li>The device(s) must not extend out of the area defined by the footprint of the four tires</li> <li>On both sides of the vehicle the devices pickup points must be indicated by orange triangles.</li> <li>The quick jack must be locked and secured. This must function without the support of a person or additional weights.</li> <li>Clearly visible UNI name written on a high contrast background</li> </ul>	T13.2		
18	<b>DOCUMENTS PRESENT</b> <ul style="list-style-type: none"> <li>SES present</li> <li>IAD present</li> <li>Laminate/test samples present</li> </ul>	INS.1.1		
VEHICLE IDENTIFICATION (T12)				
No.	Checkpoint	Rule No	Checkbox	Comments
19	Main scrutineering sticker	IN1.3		
20	<b>VEHICLE NUMBER</b> <ul style="list-style-type: none"> <li>Placed on front and both sides</li> <li>Height: at least 150mm high</li> <li>Stroke width and spacing between numbers: at least 20mm</li> <li>Color: Either white numbers on a black background or black numbers on a white background</li> <li>Background shape: The number background must be one of the following: round, oval, square or rectangular. There must be at least 25mm between the edge of the numbers and the edge of the background</li> <li>Clear: The numbers must not be obscured by parts of the vehicle</li> </ul>	T12.1		
21	<b>UNIVERSITY NAME</b> <ul style="list-style-type: none"> <li>must be written fully, accepted abbreviations: <ul style="list-style-type: none"> <li>University: Uni</li> <li>Technical University: TU</li> <li>University of Applied Sciences: UAS</li> <li>Berufsakademie: BA</li> </ul> </li> <li>If the university officially uses an abbreviation in their proper name, this abbreviation is accepted</li> <li>at least 50mm high on both sides of the vehicle on a high contrast background</li> </ul>	T12.2		
DRIVER RESTRAINT SYSTEM (T5) with TALLEST driver seated (ready to race state)				
No.	Checkpoint	Rule No	Checkbox	Comments
22	Car in ready to race condition and clean	INS.1.1		
23	Check bracelet for tallest driver	INS.1.1		
24	<b>GROUND CLEARANCE (EV - WITH E STICKERS AND ACCUMULATOR INSIDE)</b> <ul style="list-style-type: none"> <li>clearance + 30mm</li> </ul>	T2.2.1		
25	<b>SUSPENSION (EV - CHECK WITH E STICKERS AND ACCUMULATOR INSIDE)</b> The vehicle must be equipped with fully operational front and rear suspension systems including shock absorbers and a usable wheel travel of at least 50mm and a minimum jounce of 25mm <b>with driver seated</b> .	T2.4.1		

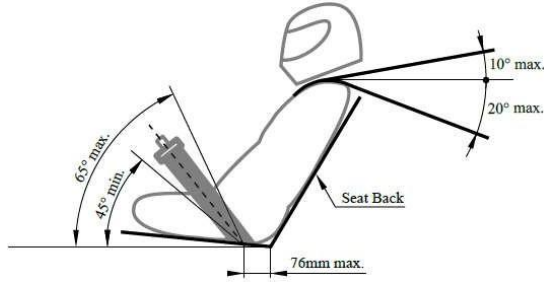
26	<p><b>HARNESS TYPE</b>                  A six or seven point harness is installed with the one of the following certifications:                  • SFI Specification 16.1, SFI Specification 16.5                  • or FIA specification 8853/98.                  • or FIA specification 8853/2016.                  Date on belts must be valid:                  SFI spec harnesses must be replaced following December 31st of the 2nd year after the date of manufacture as indicated by the label. FIA spec harnesses must be replaced following December 31st of the year marked on the label.</p>	T5.2		
27	<p><b>DRIVING POSITION</b>                  Note <b>reclined</b> or <b>upright</b> driving position:                  upright position – Position with a seat back angled at 30° or less from the vertical reclined position – Position with a seat back angled at more than 30° from the vertical</p> 	T5.1.3 T5.1.4		
28	<p><b>LAP BELT</b>                  • Securely attached to Primary Structure                  • Reclined: between 45° &amp; 60° from horizontal                  • Upright: between 60° &amp; 80° from horizontal                  • From anchor point straight to drivers body                  • In side view it must be capable of pivoting freely</p>	T5.4		
29	<p><b>SHOULDER HARNESS</b>                  • Width: Without HANS Device: 75mm, With HANS Device: 50mm (T5.2.1)                  • 180-230 mm apart measured center to center                  • Between -20° &amp; +10° from horizontal                  • Tilt lock adjuster                  • From anchor point straight to drivers body                  • Must not pass through the firewall</p>	T5.5		
30	<p><b>ANTI-SUBMARINE BELT</b>                  • With the belts going vertically down from the groin, or angled up to 20° rearwards. The anchorage points should be approximately 100 mm apart.                  • Anchorage points must be on the primary structure at or near the lap belt anchorages                  • can use the same attachment point as the lap belts</p>	T5.6		
31	<p>Harnesses, belts and straps must not pass through a firewall, i.e. all harness attachment points must be on the driver's side of any firewall.</p>	T5.3.2		
32	<p>The lap belts and anti submarine belts must not be routed over the sides of the seat.                  • Where the belts or harness pass through a hole in the seat, the seat must be rolled or grommited to prevent chafing of the belts.</p>	T5.3.3		
<b>SAFETY CHECKS with TALLEST driver seated (ready to race state)</b>				
No.	Checkpoint	Rule No	Checkbox	Comments
<b>HEAD RESTRAINT - PADDING</b>				
33	• Be vertical or near vertical in side view.			
34	• Minimum thickness of 40mm			

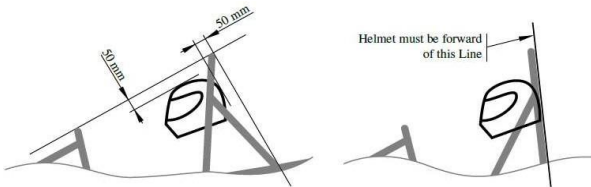
35	<ul style="list-style-type: none"> <li>• Be padded with an energy absorbing material:                     <ul style="list-style-type: none"> <li>-that meets either the SFI 45.2 standard</li> <li>-or is listed in the FIA technical list n°17 as a type B material for single seater cars</li> </ul> </li> </ul>			
36	<ul style="list-style-type: none"> <li>• Have a minimum width of 150 mm</li> <li>• Have a minimum height of 150 mm</li> </ul>	T5.7.2		
37	<ul style="list-style-type: none"> <li>• Be located so that for each driver:                     <ul style="list-style-type: none"> <li>– The restraint is no more than 25mm away from the back of the driver’s helmet, with the driver in their normal driving position.</li> <li>– The contact point of the back of the driver’s helmet on the head restraint is no less than 50mm from any edge of the head restraint.</li> </ul> </li> </ul>			
38	<ul style="list-style-type: none"> <li>• The head restraint and its mounting must withstand a force of 890N applied in the rearward direction at any point on its surface.</li> </ul>	T5.7.3		
39	<p>Roll bar or bracing that could be hit by driver’s helmet must be covered with 12 mm thick padding;</p> <ul style="list-style-type: none"> <li>• SFI spec 45.1 or FIA 8857-2001</li> </ul> <p><i>Gently move the driver’s head to make sure that any object that comes in contact with it is covered by padding, or has sufficient clearance.</i></p> <p><i>Pay attention to the connections of the shutdown buttons mounted on the Main Hoop.</i></p>	T5.8.1		
40	<p><b>VEHICLE CONTROLS</b></p> <ul style="list-style-type: none"> <li>• All vehicle controls must be operated from inside the cockpit without any part of the driver, e.g. hands, arms or elbows, being outside the vertical planes tangent to the outermost surface of the side impact structure.</li> </ul>	T4.9.1		
41	<p><b>FIELD VIEW</b></p> <ul style="list-style-type: none"> <li>• Minimum of 100 deg. field view either side. Head rotation allowed or mirrors. If mirrors, must be firmly installed and adjusted</li> </ul>	T4.10		
42	<p><b>MAIN HOOP &amp; FRONT HOOP HEIGHTS</b></p> <p>When seated normally and restrained by the driver’s restraint system, the helmet of the tallest driver must:</p> <ul style="list-style-type: none"> <li>• Be a minimum of 50mm away from the straight line drawn from the top of the main hoop to the top of the front hoop.</li> <li>• Be a minimum of 50mm away from the straight line drawn from the top of the main hoop to the lower end of the main hoop bracing if the bracing extends rearwards.</li> <li>• Be no further rearwards than the rear surface of the main hoop if the main hoop bracing extends forwards.</li> </ul> 	T4.3.1		
43	<p><b>DRIVER'S FOOT PROTECTION</b></p> <ul style="list-style-type: none"> <li>• The feet of the driver must within the primary structure in all views when touching the pedals</li> </ul>			
44	<p><b>SHUTDOWN BUTTONS</b></p> <p>One shutdown button serves as a cockpit-mounted shutdown button and must</p> <ul style="list-style-type: none"> <li>• have a minimum diameter of 24mm</li> <li>• be located in easy reach of a belted-in driver</li> <li>• be alongside of the steering wheel and unobstructed by the steering wheel or any other part of the vehicle</li> <li>• the international electrical symbol consisting of a red spark on a white-edged blue triangle must be affixed in close proximity</li> </ul>	T11.4.4		
45	<p><b>CAMERA MOUNTS</b></p> <p>The body of any video/photographic camera which is not exclusively used as sensor for the AS unit must be secured at a <b>minimum of two points on different sides of the camera body</b>. If a tether is used to restrain the camera, the tether length must be limited so that the camera cannot contact the driver.</p>	T11.10.5		
<b>APPROVAL STATUS</b>			gid=0	
MECH 1	Approval (Control box) (DON'T CHANGE MANUALLY)		ONWAAR	

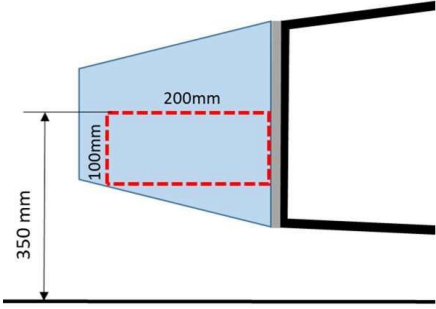
MECH 2				
<b>!ONLY FOR EV! CHECK IF THE TEAM HAS BOTH E STICKERS! IF NOT THE ACCUMULATOR MUST NOT BE PRESENT!</b>				
PRESENT DOCUMENTS				
No.	Checkpoint	Rule No	Checkbox	Comments
46	Approved SES	T3.6		
47	Approved SESA (if applicable, monocoque only)	A5.7		
48	IA test specimen and approved IA data (except for teams with a standard IA)	T3.18		
49	Laminate test specimens	T3.5		
GENERAL				
No.	Checkpoint	Rule No	Checkbox	Comments
50	The chassis has to be constructed with node-to-node triangles: All structural frame members must meet the min. material requirements <ul style="list-style-type: none"> <li>• Two roll hoops that are braced</li> <li>• A front bulkhead with support system and IA</li> <li>• Side impact structures</li> <li>• All hoops and bracings must meet the min. material requirements</li> </ul>	T3.1		
51	Wheelbase has to be a minimum of 1525 mm	T2.8.1		
FRONT IMPACT PROTECTION (REMOVE NOSE)				
No.	Checkpoint	Rule No	Checkbox	Comments
IMPACT ATTENUATOR ASSEMBLY (IA AND AIP)				
52	<ul style="list-style-type: none"> <li>• The attachment of the IA assembly must be designed to provide an adequate load path for transverse and vertical loads in the event of off-center and off-axis impacts.</li> <li>• Segmented foam attenuators must have the segments bonded together to prevent sliding or parallelogramming.</li> </ul>	T3.17.6		
53	<b>BOLTED</b> <ul style="list-style-type: none"> <li>• If the IA assembly is bolted to the FBH, it must be the same size as the outside dimensions of the front bulkhead</li> <li>• One 8mm metric grade 8.8 bolt must be used for every 200mm of reference perimeter. Smaller but more bolts may be used if equivalency is shown. The bolts are considered critical fasteners (T10)</li> </ul> <p><i>Check for positive locking</i></p>	T3.16.6 T3.17.3		
54	<b>WELDED</b> <ul style="list-style-type: none"> <li>• If it is welded to the front bulkhead, it must extend at least to the centerline of the front bulkhead tubing in all directions.</li> </ul>			
55	<ul style="list-style-type: none"> <li>• The AIP must not extend past the outside edges of the front bulkhead.</li> </ul>			
IMPACT ATTENUATOR				
56	<ul style="list-style-type: none"> <li>• At least 100mm high and 200mm wide for a minimum distance of 200mm forward of the front bulkhead.</li> </ul>	T3.17.2		
57	<ul style="list-style-type: none"> <li>• No portion of the required 100 × 200 × 200 mm<sup>3</sup> volume of the IA can be positioned more than 350 mm above the ground.</li> </ul> 	T3.17.2		
58	<ul style="list-style-type: none"> <li>• Attached securely and directly to the Anti Intrusion Plate (AIP).</li> <li>• No wing supports through IA</li> </ul>	T3.17.2		

59	<ul style="list-style-type: none"> <li>Attached to the AIP by a minimum of four 8 mm metric grade 8.8 bolts. The bolts are considered critical fasteners and must comply with T 10.</li> </ul>	T3.17.5		
60	<p>For "standard" FSAE IAs:</p> <ul style="list-style-type: none"> <li>if the FBH width is larger than 400 mm and/or its height is larger than 350 mm a diagonal or X-bracing that is a front bulkhead support tube or an approved equivalent per T 3.2, must be included in the front bulkhead. Or equivalent for monocoque bulkheads.</li> <li>must use a 1.5 mm solid steel AIP that is welded along its full perimeter to a steel bulkhead or use a 4 mm solid aluminium AIP that is bolted to any bulkhead with a minimum of eight 8 mm metric grade 8.8 bolts</li> </ul>	T3.17.7		
61	<p><b>ANTI INTRUSION PLATE (AIP)</b></p> <ul style="list-style-type: none"> <li>Thickness = min 1.5mm solid steel or 4.0mm aluminium.</li> <li>Alternative AIP designs are permissible if equivalency to T 3.17.3 is proven by physical testing as in T 3.19.2. (Check SES and IAD)</li> </ul>	T3.17.3 T3.17.4		
<b>FRONT STRUCTURE</b>				
No.	Checkpoint	Rule No	Checkbox	Comments
62	<p><b>FRONT BULKHEAD</b></p> <ul style="list-style-type: none"> <li>Any alternative material used for the front bulkhead must have a perimeter shear strength equivalent to a 1.5 mm thick steel plate.</li> <li>The front bulkhead must be supported back to the front hoop by a minimum of three tubes on each side</li> </ul>	T3.13 T3.14		
63	<p><b>FRONT BULKHEAD SUPPORT</b></p> <ul style="list-style-type: none"> <li>Must support the FBH back to Front Hoop by minimum 3 tubes on each side</li> <li>UPPER MEMBER <ul style="list-style-type: none"> <li>attached to FBH maximum 50mm from the top and to the FH maximum of 50mm below the upper SIS member</li> <li>If attachment point is more than 100mm above the upper SIS member, triangulation is needed to transfer load to the MH</li> </ul> </li> <li>LOWER MEMBER: attached to the base of the FBH and the base of the FH</li> <li>DIAGONAL MEMBER: must triangulate the upper and lower member node-to-node</li> </ul>	T3.14		
64	<p><b>FRONT HOOP BRACING</b></p> <ul style="list-style-type: none"> <li>The front hoop bracing attaches on each side of the front hoop as well as the structure forward of the driver's feet. A minimum of two tubes without any bends must be straight on a line in side view of the frame and <b>must have a minimum distance of 100 mm between each other at the front hoop</b></li> <li>Attached to front hoop <b>not lower than 50mm from top-most surface</b> of the front hoop (not applicable for monocoque)</li> <li>If the front hoop is inclined more than 10° to the rear, additional braces extending rearwards are required</li> </ul>	T3.11		
<b>FRONT HOOP (T3.9)</b>				
65	<ul style="list-style-type: none"> <li>Material must be <b>metal</b> with a wall <b>thickness at least 2 mm</b> (<i>inspeccion holes if needed</i>)</li> </ul>	T3.2.1		
66	<ul style="list-style-type: none"> <li>In side view, <b>no part</b> of the front hoop can be <b>inclined more than 20°</b> from vertical.</li> </ul>	T3.9.3		
67	<ul style="list-style-type: none"> <li>The lower roll hoop tubing attachment points must be within <b>50 mm</b> of the endpoints of the roll hoop. (T3.7.4)</li> </ul>	T3.7.4		
<b>FRONT HOOP ATTACHMENT</b>				
68	<ul style="list-style-type: none"> <li>Check if the submitted design matches the structure on the car</li> </ul>			
69	<ul style="list-style-type: none"> <li>Check proper manufacturing</li> </ul>			
70	<p><b>BOLTED FH</b></p> <ul style="list-style-type: none"> <li>The front hoop requires six attachment points, two on each side connecting to the front bulkhead support structures and two connecting to the front hoop bracing, and must therefore show equivalency to 180 kN, as follows from T 3.16.1 and T 3.11.4.</li> </ul>	T3.9.5		

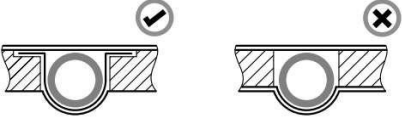

71	<ul style="list-style-type: none"> <li>Each attachment point requires a minimum of <b>two 8 mm metric grade 8.8 bolts</b> and <b>steel backing plates</b> with a minimum thickness of <b>2 mm</b>.</li> </ul>	T3.16.3		
72	<ul style="list-style-type: none"> <li>Check e/D of attachments (&gt; 1.5 Hole Diameter)</li> </ul>	T10.1.4		
73	<p>LAMINATED FH</p> <ul style="list-style-type: none"> <li>Fully laminating the front hoop to the monocoque is acceptable. Fully laminating means that the hoop has to be encapsulated with laminate around its whole circumference, see figure 5. Equivalence to T 3.7.4 must be shown in the SES. The laminate encapsulating the front hoop must overlap by at least 25 mm on each side. It must have the same lay-up as the laminate that it is connecting to.</li> </ul> <p><i>(The manufacturing quality is to be checked - dry areas, insufficient overlap, bad laminating quality)</i></p>  <p>Figure 5: Front hoop laminating requirements</p>	T3.9.6		

**MAIN HOOP**

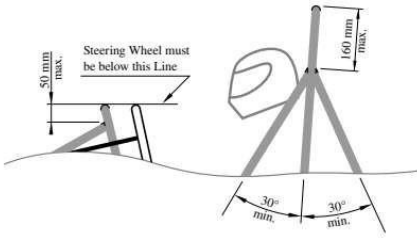
No.	Checkpoint	Rule No	Checkbox	Comments
74	<p><b>MAIN HOOP</b></p> <ul style="list-style-type: none"> <li>The main hoop must be constructed of a single piece of uncut, continuous, closed section steel tubing.</li> <li>Material must be steel with a wall thickness at least 2 mm (T3.2.1) <i>(inspection holes if needed)</i></li> <li>In side view the portion of the main hoop which is above its upper attachment point to the side impact structure must be inclined less than 10° from vertical</li> <li>In side view any portion lower than the upper attachment point to the side impact structure must be inclined either forward or not more than 10° rearward</li> <li>In side view any bends in the main hoop above its upper attachment point to the primary structure must be braced to a node of the main hoop bracing support structure with tubing meeting the requirements of main hoop bracing.</li> <li>The lower roll hoop tubing attachment points must be within 50 mm of the endpoints of the roll hoop. (T3.7.4)</li> </ul>	T3.8 T3.7		
75	<p><b>MAIN HOOP BRACING</b></p> <ul style="list-style-type: none"> <li>Material must be steel and the bracings must be straight.</li> <li>Bracings must be attached to the main hoop no lower than 160 mm below the top-most surface of the main hoop. The angle between bracings and main hoop must be greater than 30 deg.</li> <li>Proper construction for removable braces (if applicable) see T3.12</li> <li>If any item which extends outside of the primary structure is attached to the main hoop braces, additional bracing is required to prevent bending loads in a rollover situation. <i>(Usually rear wing supports, applies to anything that induces loads to the Main Hoop Bracing tubes)</i></li> </ul>  <p>Figure 6: Front hoop bracing, main hoop bracing and steering wheel requirements</p>	T3.10		

76	<b>SHOULDER HARNESS BAR / MOUNTING</b> <ul style="list-style-type: none"> <li>• Minimum thickness 2mm (T3.2.1)</li> <li>• Must be steel</li> <li>• Must not transfer load to the Main Hoop Bracing without additional triangulation-bracing</li> <li>• <b>Check attachment calculations on SES and compare the attachments on the car with the ones submitted</b></li> </ul>	T5.5		
<b>MAIN HOOP ATTACHMENTS</b>				
77	• Check if the submitted design matches the structure on the car			
78	<ul style="list-style-type: none"> <li>• Each attachment point requires a <b>minimum of two 8 mm metric grade 8.8 bolts and steel backing plates</b> with a minimum thickness of <b>2 mm</b>.</li> <li>• Or <b>one 10 mm metric grade 8.8 bolt</b>, if the bolt is on the centerline of the tube</li> </ul>	T3.16.3 T3.16.4		
79	• Check e/D of attachments (> 1.5 Hole Diameter)	T10.1.4		
80	• Check positive locking (nylon nuts allowed if area is less than 80 degrees)	T10.1.1 T10.2.2		
81	• Check proper manufacturing			
<b>TEMPLATE FITTING</b>				
No.	Checkpoint	Rule No	Checkbox	Comments
82	<b>COCKPIT OPENING</b> <ul style="list-style-type: none"> <li>• Insert template 2 into cockpit. The firewall may not be removed. Teams are allowed to remove the seat, steering wheel and all padding</li> <li>• Template passes down below the top of the Side Impact Structure (or 320mm above lowest point in car, monocoque only)</li> </ul>	T4.1		
83	<b>COCKPIT INTERNAL CROSS SECTION</b> <ul style="list-style-type: none"> <li>• Check if pedals are in <b>most forward</b> position.</li> <li>* <b>MOST FORWARD = TOWARDS FRONT BULKHEAD</b></li> <li>* <b>REARWARDS = TOWARDS MAIN HOOP</b></li> <li>• Insert template 3 into cockpit. Steering wheel and padding may only be removed if no tools are required and the driver is able to do so from the driving position.</li> <li>• Template passes through to 100mm from rearmost pedal face.</li> </ul>	T4.2		
84	<b>DRIVER'S LEG PROTECTION</b> <ul style="list-style-type: none"> <li>• All moving suspension and steering <b>components</b> and other <b>sharp</b> edges inside the cockpit between the front hoop and a vertical plane 100 mm rearward of the pedals, must be shielded with solid material.</li> </ul>	T5.9.1		
85	• Check if anything from the rear of the pedal box (brake lines, cables etc.) is forward than the inner FBH skin, or is crimped-crashed to it.			
86	<b>PERCY</b> Insert percy into cockpit The figure has to be positioned in the vehicle as follows: <ul style="list-style-type: none"> <li>• The seat adjusted to the rearmost position (<b>REARMOST = TOWARDS MAIN HOOP</b>)</li> <li>• The pedals adjusted to the frontmost position (<b>FRONTMOST = TOWARDS FRONT BULKHEAD</b>)</li> <li>• The bottom 200mm circle placed on the seat bottom. The distance between the center of the circle and the rearmost actuation face of the pedals must be minimum 915mm.</li> <li>• The middle circle positioned on the seat back</li> <li>• The upper 300mm circle positioned 25mm away from the head restraint.</li> <li>• Top is at least 50mm below the line between the main hoop and front hoop</li> </ul>	T4.3		
<b>SIDE IMPACT STRUCTURE</b>				
No.	Checkpoint	Rule No	Checkbox	Comments

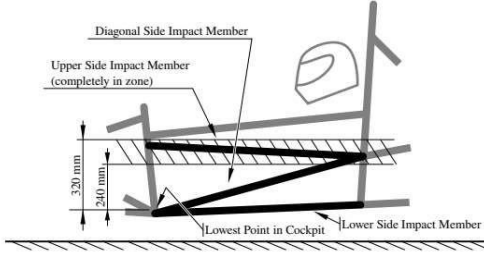
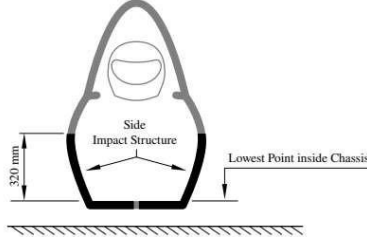
87	<p><b>SIDE IMPACT STRUCTURE (T3.15)</b></p> <ul style="list-style-type: none"> <li>• Must consist of at least three members on each side</li> <li>• UPPER MEMBER: must connect the front and main hoop and must be at a height of 240mm and 320 mm above the lowest inside chassis point between the front and main hoop</li> <li>• LOWER MEMBER: must connect the bottom of the main hoop and the bottom of the front hoop</li> <li>• DIAGONAL MEMBER: must triangulate the upper and lower member between the roll hoops node-to-node.</li> </ul>  <p style="text-align: center;">Figure 9: Side impact structure</p>  <p style="text-align: center;">Figure 10: Side impact structure monocoque</p>	T3.15		
----	--	-------	--	--

**HARNES ATTACHMENTS**

No.	Checkpoint	Rule No	Checkbox	Comments
88	• Check if the submitted design matches the structure on the car			
89	• Check if the submitted test configuration matches the structure on the car			
90	<ul style="list-style-type: none"> <li>• If attached to monocoque <b>one 10 mm metric grade 8.8 bolt</b> or <b>two 8 mm metric grade 8.8 bolts</b> (or bolts of an equivalent standard) and steel backing plates with a minimum thickness of 2 mm. If no backing plates are used check thoroughly the testing presented</li> <li>• If attached to the primary structure using brackets must use two 8 mm metric grade 8.8 or stronger fasteners.</li> </ul>	T4.5.1 T4.5.2		
91	• Check positive locking (nylon nuts allowed if area is less than 80 degrees)	T10.1.1 T10.2.2		
92	• Minimum thickness 1.6mm steel or 4mm aluminium (if not, testing to be presented)	T4.5.5		

**ACCUMULATOR CONTAINER (EV5.5)**

**!ONLY IF THE TEAM HAS PASS BOTH E INSPECTIONS - CHECK STICKERS!**

No.	Checkpoint	Rule No	Checkbox	Comments
	<b>ACCUMULATOR CONTAINER ATTACHMENTS</b> <b>(EV - CHECK WITH E STICKERS AND ACCUMULATOR PRESENT)</b>			
93	• Check if the submitted design matches the structure on the car			
94	• Any brackets used to mount the TSAC must be made of steel 1.6 mm thick or aluminum 4 mm thick and must have gussets to carry bending loads. Each attachment point including brackets, backing plates, and inserts, must be able to withstand 20 kN in any direction.	EV5.5.13		
95	• Each attachment point requires steel backing plates with a minimum thickness of 2 mm. Alternate materials may be used for backing plates if equivalency is approved. <i>(Check SES)</i>	EV5.5.5		
96	• Check e/D of attachments (> 1.5 Hole Diameter)	T10.1.4		
97	• Check positive locking (nylon nuts allowed if area is less than 80 degrees)	T10.1.1 T10.2.2		
98	• Check proper manufacturing			
<b>APPROVAL STATUS</b>			<u>gid=0</u>	
MECH 2	Approval (Control box) (DON'T CHANGE MANUALLY)		ONWAAR	

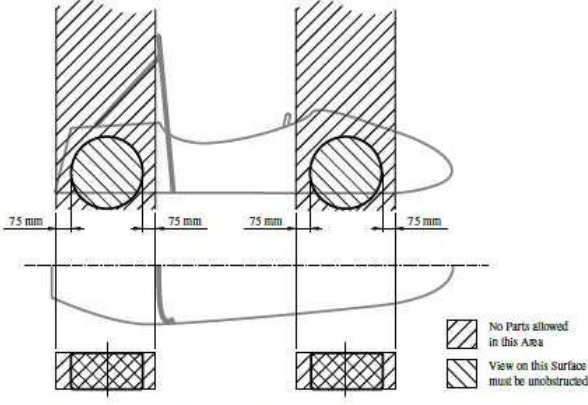

MECH 3 - FULLY ASSEMBLED WITHOUT DRIVER				
!ONLY FOR EV! CHECK IF THE TEAM HAS BOTH E STICKERS! IF NOT THE ACCUMULATOR MUST NOT BE PRESENT!				
BODYWORK & AERODYNAMICS				
No.	Checkpoint	Rule No	Checkbox	Comments
99	<ul style="list-style-type: none"> <li>No large holes in bodywork, except for cockpit opening and except for the venting holes</li> </ul>	T2.3.1		
100	<b>FLOOR PANELS</b> <ul style="list-style-type: none"> <li>Floor panel installed from foot area until firewall. <b>Gaps must be less than 3mm</b></li> <li>Deflection of floor panels which can occur with a seated driver or during a race can't cause a gap greater than 3mm</li> <li>Enclosed chassis structures, structures between the chassis and the ground and every local minimum that can accumulate fluids must have two venting holes of at least 25mm diameter in the lowest part of the structure to prevent accumulation of liquids.</li> </ul>	T4.7.1		
101	<b>GROUND CLEARANCE</b> <ul style="list-style-type: none"> <li>Check if the car has passed ground clearance (M1)</li> </ul>	T2.2.1		
AERO GENERAL				
102	<b>REAR AERO (WITH E STICKERS AND ACCUMULATOR INSIDE)</b> Measurements according T8 aerodynamic devices, figure 16 (Provided in scrutineering area)	T8		
103	<ul style="list-style-type: none"> <li><b>Front facing edges</b> of aero dives must have a radius of 5 mm if horizontal and 3 mm if vertical and 38mm radius at 45° at the nosecone</li> </ul>	T8		
104	<ul style="list-style-type: none"> <li>Attachment of the rear wing must be in the nodes of the MAIN HOOP (MAIN HOOP BRACINGS)</li> </ul>			
105	No parts are allowed within the 75 mm keep out zone (see image below)   <p style="text-align: center;">Figure 3: Keep-out-zones for the definition of an open-wheeled vehicle.</p>	T8		
106	<b>FRONT AERO (EV - WITH E STICKERS AND ACCUMULATOR INSIDE)</b> Measurements according T8 aerodynamic devices, figure 16 (Provided in scrutineering area)	T8		

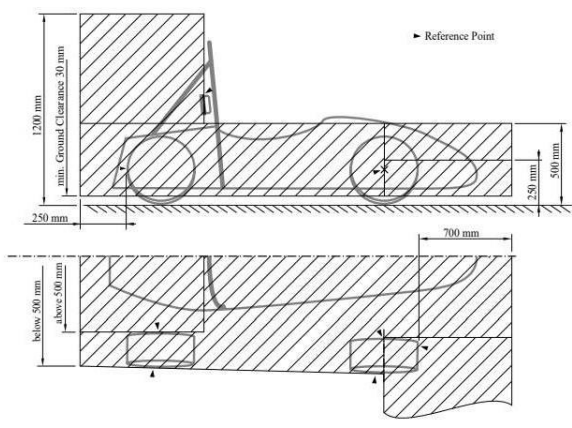
<p>107</p>	<p><b>REAR AERO (WITH E STICKERS AND ACCUMULATOR INSIDE)</b> Measurements according T8 aerodynamic devices, figure 16 (Provided in scrutineering area)</p>  <p>Figure 16: Maximum dimensions and positioning of aerodynamic devices. The positioning space is further restricted, see T2.1.</p>	<p>T8</p>		
------------	--	-----------	--	--

<p>108</p>	<p><b>TSAL</b> The TSAL must:</p> <ul style="list-style-type: none"> <li>• Be located lower than the highest point of the main hoop and including the mounting within the roll over protection envelope, see T1.1.15.</li> <li>• Be no lower than 75mm from the highest point of the main hoop.</li> <li>• Not be able to contact the driver's helmet in any circumstances.</li> </ul> <p>The entire illuminated surface of the TSAL must be clearly visible:</p> <ul style="list-style-type: none"> <li>• Except for angles less than 10° which are blocked by the main hoop.</li> <li>• From a point 1.60m vertically from ground level within 3m horizontal radius from the TSAL.</li> <li>• In direct sun light.</li> </ul>	<p>EV4.10.8</p>		
------------	---	-----------------	--	--

COOLING SYSTEM (T7.2)				
	Checkpoint	Rule No	Checkbox	Comments
	<b>COOLING GENERAL</b>	T7.2		
109	<p><b>COOLANT FLUID</b></p> <ul style="list-style-type: none"> <li>• CV - Water-cooled engines must only use <b>plain water</b>.</li> <li>• EV - TS components may only use <b>plain water, air or oil</b> as the coolant, see T 1.2.2</li> </ul>	T 7.2.1 T 7.2.2		
110	<ul style="list-style-type: none"> <li>• Cooling systems using plain water (except outboard wheel motors and their cooling hoses) must have a heat resistant (Permanently rated for at least 100 °C), <b>rigid and rigidly mounted cover</b> which meets the requirements of T 4.8.2.</li> </ul>	T 7.2.3		
111	<ul style="list-style-type: none"> <li>• Any cooling overflow system must be equipped with a catch tank, located behind the firewall, below shoulder level</li> </ul>	T 7.2.8		
112	<ul style="list-style-type: none"> <li>• Cooling catch cans minimal 10% fluid volume or 100ml, whichever is greater.</li> </ul>	T 7.2.6		
113	<ul style="list-style-type: none"> <li>• Other fluids must have a minimum volume of 10% of the fluid being contained or 900 ml whichever is greater.</li> </ul>	T 7.2.5		
114	<ul style="list-style-type: none"> <li>• No fluid hoses out of the chassis or monocoque in direct line of sight of driver exceptions for in-wheel motors. Without stone-strike protection</li> </ul>			
115	<ul style="list-style-type: none"> <li>• All parts of the engine cooling and lubrication system, <b>including their mountings</b>, must be rated for <b>at least 120 °C</b> or the temperatures the respective fluid may reach, <b>whichever is higher</b>.</li> </ul>	T 7.2.7		

116	Any catch can must vent through a hose with a minimum internal diameter of 3mm down to the bottom level of the chassis and must exit outside the bodywork.	T7.2.9		
117	<b>FLUID LEAKS</b> No type of fluid leak (Oil, grease, coolant, fuel, Brake fluid) is permitted			
DRIVE TRAIN SHIELDS AND GUARDS (T7.3)				
No.	Checkpoint	Rule No	Checkbox	Comments
118	<b>Oil pump lower than chassis</b> • The lowest point of any lubrication system can only be lower than the line between the lowest point of the main hoop and the lowest chassis member behind the lubrication system if it is protected from hitting the ground by a structure mounted directly to the chassis.	T7.3.1		
119	Exposed <b>rotating final drivetrain parts</b> , such as <b>gears, clutches, chains and belts</b> must be fitted with scatter shields. Scatter shields and their mountings must: • Be constructed of non-perforated 2 mm steel or 3 mm aluminium alloy 6061-T6. • Cover chains and belts from the drive sprocket to the driven sprocket/chain wheel/belt or pulley. • Start and end parallel to the lowest point of the driven sprocket/chain wheel/belt or pulley. • Scatter shields for chains and belts must be centered on the centerline of the chain or belt and remain aligned with the chain or belt under all conditions. • For non-metallic chains and belts: 3mm nonperforated aluminum alloy 6061-T6. • The minimum width of the scatter shield should be at least three times the width of the chain or belt.	T 7.3.2		
120	• All fasteners attaching scatter shields, guards and their mountings must be 6mm metric grade 8.8 or stronger and must comply with T10.1.	T7.3.2		
121	• Finger guards are required to cover any parts that spin while the vehicle is stationary. Finger guards may be made of lighter material, sufficient to resist finger forces. Mesh or perforated material may be used but must prevent the passage of a 12mm diameter object through the guard.	T7.3.5		
122	<b>MOTORCASING</b> • EV - Motorcasings must have a housing or separate scatter shield from <b>non perforated 2 mm aluminium alloy 6061-T6 or equivalent</b> . The scatter shield may be split into two equal sections, each 1 mm thick.	T7.3.4		
123	<b>GREASE COVERS</b> • All covers off drivesystems have to be fixated so the grease wont come out			
FIREWALL (T4.8)				
No.	Checkpoint	Rule No	Checkbox	Comments
124	The firewall must separate the cockpit from all components of - the fuel supply system - hydraulic fluid except brake system and dampers - flammable liquids - the low voltage battery - any TS component (EV1.1.1)	T 4.8.1		
125	• The firewall must cover any straight line between the parts mentioned in T 4.8.1 and any part of the tallest driver below a plane 100 mm above the bottom of the helmet.	T 4.8.2		
126	<b>HEAT INSULATION</b> • Adequate heat insulation must be provided to ensure that the driver is not able to contact any parts of the vehicle with a surface temperature above 60 °C. The insulation may be external to the cockpit or incorporated with the driver's seat or firewall. The design must address all three types of heat transfer with the following minimum requirements between the heat source and the part that the driver could contact: (a) <b>Conduction insulation</b> by: (i) No direct contact, or (ii) a heat resistant, conduction insulation material with a minimum thickness of 8 mm. (b) <b>Convection insulation</b> by a minimum air gap of 25 mm. (c) <b>Radiation insulation</b> by: (i) A solid metal heat shield with a minimum thickness of 0.4 mm or (ii) reflective foil or tape when combined with T 4.6.2.a.ii.	T 4.6.2		

127	<ul style="list-style-type: none"> <li>The firewall must be a <b>non-permeable surface</b> made from a <b>rigid, fire resistant material</b>, see T 1.2.1, which must be <b>rigidly mounted</b> to the vehicle's structure.</li> </ul> <p>A material is considered Fire Retardant if it meets one of the following standards (<i>ask for proof</i>) :</p> <ul style="list-style-type: none"> <li><b>UL94 V-0</b> for the minimum used material thickness</li> <li><b>FAR 25.853(a)(1)(i)</b></li> </ul> <p>Equivalent standards are only accepted, if the team shows equivalence and this is approved by the officials <b>prior to the event</b>.</p>	T1.2.1T 4.8.3		
128	<ul style="list-style-type: none"> <li>Any firewall must seal completely against the passage of fluids, especially at the sides and the floor of the cockpit.</li> </ul>	T 4.8.4		
129	<ul style="list-style-type: none"> <li>Pass-throughs for wiring, cables, etc. are permitted if grommets are used to seal the passthrough.</li> </ul>	T 4.8.5		
130	<ul style="list-style-type: none"> <li>Multiple panels may be used to form the firewall but must overlap at least 5mm and be sealed at the joints. Any sealing material must not be vital to the structural integrity of the firewall.</li> </ul>	T 4.8.6		
131	<p><b>EV ONLY</b></p> <p>The TS firewall between driver and TS components must be composed of two layers:</p> <ul style="list-style-type: none"> <li>One layer, facing the TS side, must be made of aluminium with a thickness of at least 0.5 mm. This part of the TS firewall must be grounded according to EV 3.1.</li> <li>The second layer, facing the driver, must be made of an electrically insulating and fire retardant material, see T 1.2.1. The second layer must not be made of CFRP.</li> <li>The thickness of the second layer must be sufficient to prevent penetrating this layer with a 4 mm wide screwdriver and 250 N of force.</li> </ul> <p>A sample of the TS firewall must be presented at technical inspection.</p>	T 4.8.7		
132	<p><b>EV ONLY</b></p> <ul style="list-style-type: none"> <li>Conductive parts, except for the chassis and firewall mounting points, may not protrude through the TS firewall or must be properly insulated on the driver's side. The driver must not be able to touch uninsulated firewall mounting points while operating the vehicle.</li> </ul>	T 4.8.8		
133	<p><b>EV ONLY</b></p> <ul style="list-style-type: none"> <li>TS parts outside of the envelope, see EV 4.4.3, do not need a firewall.</li> </ul>	T 4.8.9		

**BELOW CV CLASS ONLY**

Check box if car is EV	ONWAAR
------------------------	--------

**CV ONLY: ENGINE, FUEL SYSTEM AND ELECTRICS**

No.	Checkpoint	Rule No	Checkbox	Comments
134	<p><b>ENGINE</b></p> <ul style="list-style-type: none"> <li>The engine(s) used to power the vehicle must be piston engine(s) using a four- stroke primary heat cycle with a displacement not exceeding 710 cm<sup>3</sup> per cycle.</li> </ul>	CV1.1		
135	<ul style="list-style-type: none"> <li>Each vehicle must be equipped with an on-board starter, which must be used to start the vehicle.</li> </ul>	CV1.2		
136	<ul style="list-style-type: none"> <li>There must be a green light next to the engine start button (as defined in CV1.2.2), that indicates that the gearbox is in neutral. It must be marked with the letter "N". This letter must have a minimum height of 25 mm.</li> </ul>	CV1.2.3		
137	<p><b>SURFACE ENVELOPE</b></p> <ul style="list-style-type: none"> <li>All parts of the engine air and fuel control systems (including the throttle and the complete air intake system, including the air filter and any air boxes) must lie within the surface envelope, see T1.1.17. ).</li> </ul>	CV1.3.1		
138	<p><b>AIR INTAKE</b></p> <ul style="list-style-type: none"> <li>Any portion of the air intake system that is less than 350mm above the ground must be shielded from side or rear impact collisions by structure built according to T3.15 (with exception of the first point under T3.15.1) and must follow T3.16 when having bolted attachments.</li> </ul>	CV1.3.2		

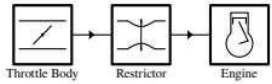
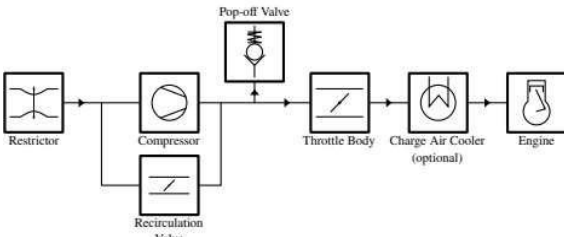

139	<ul style="list-style-type: none"> <li>The intake manifold must be securely attached to the engine block or cylinder head with brackets and mechanical fasteners. The threaded fasteners used to secure the intake manifold are considered critical fasteners and must comply with T10.Min M4, grade 8.8 OEM type M3, grade 8.8</li> </ul>	CV1.3.3		
140	<ul style="list-style-type: none"> <li>Intake systems with significant mass or cantilever from the cylinder head must be supported to prevent stress to the intake system. Supports to the engine must be rigid. Supports to the chassis must incorporate isolation to allow for engine movement and chassis torsion.</li> </ul>	CV1.3.4		
141	<ul style="list-style-type: none"> <li>The vehicle must be equipped with a throttle body. The throttle body may be of any size or design. The throttle must be actuated mechanically by a foot pedal, i.e. via a cable or a rod system, see CV1.5, or by an ETC system, see CV1.6. The throttle system mechanism must be protected from debris ingress to prevent jamming.</li> </ul>	CV1.4		
142	<p><b>THROTTLE</b></p> <ul style="list-style-type: none"> <li>The throttle actuation system must use at least two return springs located at the throttle body, so that the failure of any one of the two springs will not prevent the throttle returning to the idle position. Each return spring must be capable of returning the throttle to the idle position with the other disconnected. Springs in the Throttle Position Sensor (TPS) are not acceptable as return springs.</li> </ul>	CV1.5		
143	<ul style="list-style-type: none"> <li>Throttle cables must be located at least 50mm from any exhaust system component and out of the exhaust stream. Throttle cables or rods must have smooth operation and must not have the possibility of binding or sticking. They must be protected from being bent or kinked by the driver's foot during operation or when entering the vehicle. A positive pedal stop must be incorporated on the accelerator pedal to prevent over-stressing the throttle cable or actuation system.</li> </ul>	CV1.5		
144	<p><b>ELECTRONIC THROTTLE CONTROL</b></p> <p>Rule only applies if ETC is used.</p> <p>The ETC system must be equipped with at least the following sensors:</p> <ul style="list-style-type: none"> <li>Accelerator Pedal Position Sensors (APPSs) as defined in T11.8.</li> <li>Two Throttle Position Sensors (TPSs) to measure the throttle position</li> </ul>	CV1.6		
145	<p>When power is removed, the electronic throttle must immediately close to at least to idle position 5%. An interval of one second is allowed for the throttle to close to idle, failure to achieve this within the required interval must result in immediate disabling of power to ignition, fuel injectors and fuel pump. This action must remain active until the TPS signals indicate the throttle has returned to idle position 5% for at least one second.</p>	CV1.6.5		
146	<p>The electronic throttle must use at least two sources of energy capable of returning the throttle to the closed position. One of the sources may be the device that normally actuates the throttle, e.g. a DC motor, but the other device(s) must be a return spring that can return the throttle to the idle position in the event of a loss of actuator power.</p>	CV1.6.7		
147	<p><b>RESTRICTOR</b></p> <ul style="list-style-type: none"> <li>Gasoline fueled vehicles - 20mm</li> <li>E 85 fueled vehicles - 19mm</li> <li>For naturally aspirated engines, the sequence must be: throttle body, restrictor, and engine, see figure 17</li> <li>For turbocharged or supercharged engines, the sequence must be: restrictor, compressor, throttle body, engine, see figure 19</li> </ul> <div style="text-align: center;">  <p>Figure 18: Intake configuration for naturally aspirated engines.</p> </div> <div style="text-align: center;">  <p>Figure 19: Intake configuration for turbocharged or supercharged engines.</p> </div>	CV1.7		

148	<p><b>FUEL TANK</b></p> <ul style="list-style-type: none"> <li>The fuel tank must be located within the rollover protection envelope, see T1.1.15, except the fuel filler neck if it is 350mm above the ground.</li> </ul>	CV2.2.1		
149	<ul style="list-style-type: none"> <li>All parts of the fuel storage and supply system must lie within the surface envelope, see T1.1.17..</li> </ul>	CV2.2.2		
150	<ul style="list-style-type: none"> <li>In side view no portion of the fuel system can project below the lower surface of the chassis.</li> </ul>	CV.2.2.3		
151	<ul style="list-style-type: none"> <li>All parts of the fuel storage and supply system must be adequately protected against any heat sources and located at least 50mm from any exhaust system component.</li> </ul>	CV2.2.4		
152	<ul style="list-style-type: none"> <li>All parts of the fuel system which can come in contact with the fuel must be rated for permanent contact with fuel.</li> </ul> <p><i>Check RESIN datasheet for carbon fiber fuel tanks.</i></p>	CV2.2.5		
153	<ul style="list-style-type: none"> <li>The fuel tank is defined as the part of the fuel containment device that is in contact with the fuel. It may be made of a rigid material or a flexible material.</li> </ul>	CV2.3.1		
154	<ul style="list-style-type: none"> <li>The fuel tank must be securely attached to the vehicle structure with mountings that allow some flexibility such that chassis flex cannot unintentionally load the fuel tank.</li> </ul>	CV2.3.2		
155	<ul style="list-style-type: none"> <li>The fuel tank must not touch any part of the vehicle other than its mounting and parts of the fuel system at any time.</li> </ul>	CV2.3.3		
156	<p><b>FUEL LINES</b></p> <p>Fuel lines between fuel tank and fuel rail and return lines must have:</p> <ul style="list-style-type: none"> <li>Reinforced rubber fuel lines with an abrasion protection with a fuel hose clamp which has a full 360° wrap, a nut and bolt system for tightening and rolled edges to prevent the clamp cutting into the hose, or</li> <li>Metal braided hoses with crimped-on or reusable, threaded fittings.</li> </ul> 	CV2.4.1		
157	<p>Fuel lines must be securely attached to the vehicle and/or engine.</p>	CV2.4.3		
158	<p>The following requirements apply to LPI (low pressure injection &lt;10 bar) fuel systems:</p> <ul style="list-style-type: none"> <li>The fuel lines must comply with CV2.4.</li> <li>The fuel rail must be securely attached to the engine cylinder block, cylinder head, or intake manifold with mechanical fasteners. The threaded fasteners used to secure the fuel rail are considered critical fasteners and must comply with T10.</li> <li>The use of fuel rails made from plastic, carbon fiber or rapid prototyping flammable materials is prohibited. However, the use of unmodified Original Equipment Manufacturer (OEM) Fuel Rails manufactured from these materials is acceptable.</li> </ul>	CV2.5.1		

159	<p>The following requirements apply to HPI and DI fuel systems:</p> <ul style="list-style-type: none"> <li>• All high pressure fuel lines must be stainless steel rigid line or Aeroquip FC807 smooth bore PTFE hose with stainless steel reinforcement and visible Nomex tracer yarn. Use of elastomeric seals is prohibited. Lines must be rigidly connected every 100mm by mechanical fasteners to structural engine components.</li> <li>• The fuel rail must be securely attached to the engine cylinder head with mechanical fasteners. The fastening method must be sufficient to hold the fuel rail in place with the maximum regulated pressure acting on the injector internals and neglecting any assistance from in-cylinder pressure acting on the injector tip. The threaded fasteners used to secure the fuel rail are considered critical fasteners and must comply with T10.</li> <li>• The fuel pump must be rigidly mounted to structural engine components.</li> <li>• A fuel pressure regulator must be fitted between the high and low pressure sides of the fuel system in parallel with the DI boost pump. The external regulator must be used even if the DI boost pump comes equipped with an internal regulator.</li> <li>• Prior to the tilt test specified in IN7, engines fitted with mechanically actuated fuel pumps must be run to fill and pressure the system downstream of the high pressure pump.</li> </ul>	CV2.5.2		
160	<p>The fuel tank must have a filler neck which:</p> <ul style="list-style-type: none"> <li>• has at least an inner diameter of 35mm at any point between the fuel tank and the top of the fuel filler cap.</li> <li>• is angled at no more than 30° from the vertical</li> <li>• is accompanied by a clear fuel resistant sight tube above the top of the fuel tank with a length of at least 125mm vertical height for reading the fuel level, see figure 19.</li> <li>• is made of material that is permanently rated for temperatures of at least 120 °C.</li> <li>• a clear filler neck tube may be used as a sight tube.</li> </ul>	CV2.6		
161	<p>A permanent, non-moveable, clear and easily visible fuel level line must be located between 12mm and 25mm below the top of the visible portion of the sight tube. This line will be used as the fill line for the tilt test (IN7.1), and before and after the endurance test to measure the amount of fuel used during the endurance event.</p>	CV2.6.3		
162	<p>All fuel vent lines must be equipped with a check valve to prevent fuel leakage when the tank is inverted. All fuel vent lines must exit outside the bodywork.</p>	CV2.8.2		
163	<p>Fuel type sticker near the fuel filler neck</p>			
164	<p><b>GAS CYLINDERS/TANKS</b>  Proprietary manufactured, certified &amp; labeled.  Non-flammable gas, regulator directly on tank max. 10 bar (145 psi), securely mounted to chassis or engine, or in structural side pod, within the rollover envelope, not in cockpit, insulated from heat sources, appropriate lines &amp; fittings for max. pressure of system.  Positively retained, i.e. no tie-wraps.</p>	T 9.1		
165	<p><b>EXHAUST</b>  The exhaust outlet must be routed to the side or rear of the vehicle and so that the driver is not subjected to fumes at any speed considering the draft of the vehicle. The application of fibrous/absorbent material, e.g. "headerwrap", to the outside of an exhaust manifold or exhaust system is prohibited.</p>	CV3.1.1		
166	<p>The exhaust outlet(s) must not extend more than 450mm behind the centerline of the rear axle and shall be no more than 600mm above the ground.</p>	CV3.1.2		
167	<p>Any exhaust components (headers, mufflers, etc.) that protrude from the side of the body in front of the main hoop must be shielded to prevent contact by persons approaching the vehicle or a driver exiting the vehicle. The temperature of the outer surface must not be harmful to a person touching it.</p>	CV3.1.3		
168	<p><b>BRAKE LIGHT</b>  Only one RED brake light, clearly visible from the rear; on vehicle centerline; height between wheel centerline &amp; driver's shoulders. Round, triangle, or rectangular on black background. 15 cm2 minimum illuminated area.  LED strips OK if elements closer than 20mm apart and total length &gt; 150 mm.</p>	T 6.3		

169	<p><b>SHUTDOWN CIRCUIT</b></p> <p>The shutdown circuit directly controls all electrical power to the ignition, fuel injectors and all fuel pumps. It must act through a minimum of two mechanical relays. One relay for the fuel pump and at least one relay for injection and ignition.</p>	CV4.1		
170	<p>An LVMS according to T11.2 must completely disable</p> <ul style="list-style-type: none"> <li>• [EV ONLY] power to the LVS</li> <li>• [CV ONLY] power from the Low Voltage (LV) battery and the alternator to the LVS</li> </ul> <p>The LVMS must be mounted in the middle of a completely red circular area of 50mm diameter placed on a high contrast background.</p> <p>The LVMS must be marked with "LV" and a symbol showing a red spark in a white edged blue triangle.</p> <p>The LVMS must be removable in off state, which is in the vertical position and have a marker for the off and on positions.</p>	T11.3		
171	<p><b>SHUTDOWN BUTTONS</b></p> <p>A system of three shutdown buttons must be installed on the vehicle.</p> <p>Each shutdown button must be a push-pull or push-rotate mechanical emergency switch where pushing the button opens the shutdown circuit, see EV6.1 and CV4.1.</p> <p>One button must be located on each side of the vehicle behind the driver's compartment at approximately the level of the driver's head. The minimum allowed diameter of the shutdown buttons on both sides of the vehicle is 40mm.</p> <p>The buttons must be easy reachable from outside the vehicle.</p> <p>One shutdown button serves as a cockpit-mounted shutdown button and must</p> <ul style="list-style-type: none"> <li>• have a minimum diameter of 24mm</li> <li>• be located in easy reach of a belted-in driver</li> <li>• be alongside of the steering wheel and unobstructed by the steering wheel or any other part of the vehicle</li> </ul> <p>The international electrical symbol consisting of a red spark on a white-edged blue triangle must be affixed in close proximity to each shutdown button.</p> <p>Shutdown buttons must be rigidly mounted to the vehicle and must not be removed during maintenance.</p>	T11.4		
172	<p><b>INERTIA SWITCH</b></p> <p>An inertia switch must be part of the shutdown circuit, see CV4.1 and EV6.1, such that an impact will result in the shutdown circuit being opened. The inertia switch must latch until manually reset.</p> <p>The device must be rigidly attached to the vehicle. It must be possible to demount the device so that its functionality may be tested by shaking it.</p>	T11.5		
173	<p><b>BRAKE SYSTEM PLAUSIBILITY DEVICE - BSPD</b></p> <p>A standalone non-programmable circuit, the BSPD, must open the shutdown circuit, see EV6.1 and CV4.1, when hard braking occurs, whilst</p> <ul style="list-style-type: none"> <li>• [EV ONLY] 5kW power is delivered to the motors.</li> <li>• [CV ONLY] the throttle position is more than 25% over idle position.</li> </ul> <p>The shutdown circuit must remain open until power cycling the LVMS or the BSPD may reset itself if the opening condition is no longer present for <b>more than 10 s</b>.</p> <p>The action of opening the shutdown circuit must occur if the implausibility is persistent for more than 500 ms.</p>	T11.6		
174	<p><b>BRAKE OVER-TRAVEL SWITCH - BOTS</b></p> <p>A brake pedal over-travel switch must be installed on the vehicle as part of the shutdown circuit, as in EV6 or CV4.1. This switch must be installed so that in the event of a failure in at least one of the brake circuits the brake pedal over-travel will result in the shutdown circuit being opened. This must function for all possible brake pedal and brake balance settings without damaging any part of the vehicle.</p>	T6.2		

175	<p><b>LOW VOLTAGE BATTERIES</b></p> <p>LV batteries must be securely attached to the chassis and located within the rollover protection envelope</p> <p>Any wet-cell battery located in the cockpit must be enclosed in a non-conductive, water proof (according to IPX7 or higher, IEC 60529) and acid resistant container. Completely closed LV battery cases must have an overpressure relief. Venting gases must be separated from the driver by a firewall.</p> <p>Battery packs based on lithium chemistry <b>other than lithium iron phosphate (LiFePO4)</b>:</p> <ul style="list-style-type: none"> <li>• Must have a fire retardant casing, see T1.2.1.</li> <li>• Must include overcurrent protection that trips at or below the maximum specified discharge current of the cells.</li> <li>• Must include overtemperature protection of at least 30% of the cells, meeting EV5.8.3, that trips when any cell leaves the allowed temperature range according to the manufacturer's datasheet, but not more than 60 °C, for more than 1 s and disconnects the battery.</li> <li>• Must include voltage protection of all cells that trips when any cell leaves the allowed voltage range according to the manufacturer's datasheet for more than 500 ms and disconnects the battery.</li> <li>• It must be possible to display all cell voltages and measured temperatures, e.g. by</li> </ul>	T11.7		
<b>APPROVAL STATUS</b>		gid=0		
MECH 3	Approval (Control box) (DON'T CHANGE MANUALLY)		ONWAAR	

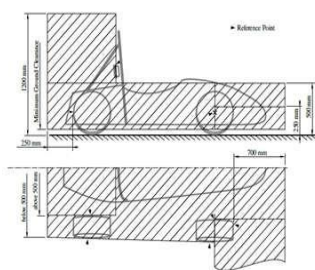

Figure 15: Maximum dimensions and positioning of aerodynamic devices. The positioning space is further restricted, see T2.1.

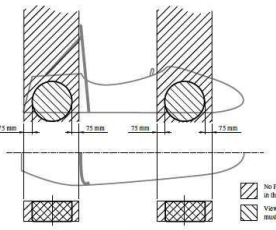

Figure 3: Keep-out-zones for the definition of an open-wheeled vehicle

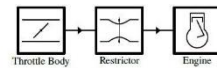

Figure 17: Intake configuration for naturally aspirated engines.

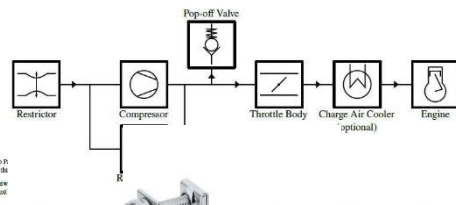
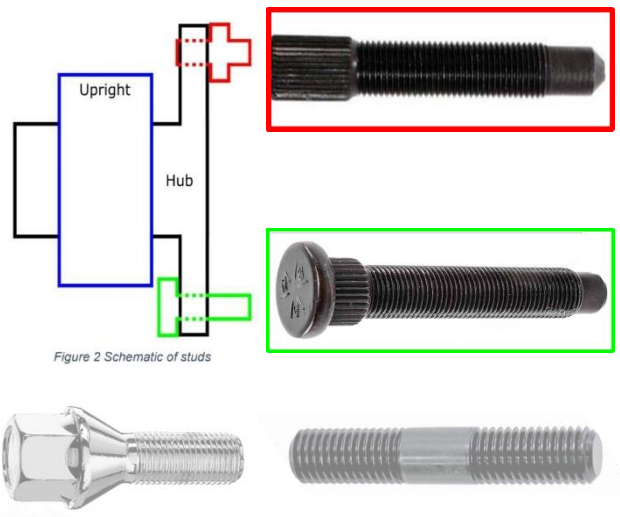

Figure 18: Intake configuration for turbocharged engines.

MECH 4				
!ONLY FOR EV! CHECK IF THE TEAM HAS BOTH E STICKERS! IF NOT THE ACCUMULATOR MUST NOT BE PRESENT!				
WHEELS (T2.5) (VEHICLE ON THE GROUND)				
No.	Checkpoint	Rule No	Checkbox	Comments
WHEEL FREE PLAY				
	<p><i>GUIDELINES</i></p> <ul style="list-style-type: none"> <li>• Check the wheels' free play in both <b>TOE</b> and <b>CAMBER</b> direction</li> <li>- Play in camber direction can be treated with more leniency within reasonable levels.</li> <li>- Play in TOE direction in REAR wheels must be barely existent</li> <li>- Force capable to rock the vehicle should be applied</li> <li>- Larger wheels are usually expected to have more play (more leverage)</li> <li>- While moving the wheels, inspect the A-arm mounting points on the chassis as well as the mounting points inside the rim.</li> <li>- While moving the REAR wheels, inspect the TOE link mounting points (on the chassis and on the wheel assembly)</li> <li>- If the suspension is mounted to the uprights with brackets, the brackets need to be rigid (check for deflections)</li> </ul>			
176	• FRONT LEFT			
177	• FRONT RIGHT			
178	• REAR LEFT			
179	• REAR RIGHT			
WHEEL FASTENING				
180	<p><b>WHEEL NUTS</b></p> <ul style="list-style-type: none"> <li>• If a single nut is used to retain the wheel, a device must be incorporated to prevent loosening of the nut and the wheel. A second nut (jam nut) is not allowed.</li> </ul>	T2.5.1		
181	<ul style="list-style-type: none"> <li>• Custom wheel nuts must show proof of good engineering practices. Purchased single nut systems must show proof of purchase.</li> <li>- Ask for pretension force of the wheel lug assembly</li> </ul>			
182	<p><b>No safety wiring for positive locking of center wheel nuts.</b> Only proper industrially manufactured cotter pins, center lock wheel springs or mechanisms compliant with T10.2</p>			
183	<p><b>WHEEL LUG BOLTS - STUDS - NUTS</b></p> <ul style="list-style-type: none"> <li>• Wheel lug bolts and studs must be made of steel or titanium. The team must be able to show good engineering practice and providing adequate strength by calculations. Wheel lugbolts and studs must not be hollow.</li> <li>• Aluminum wheel nuts may be used, but they must be hard anodized and in pristine condition.</li> <li>• Wheel nuts must comply with T 10.2. An exception is made for commercially designed fasteners designated for wheels. In this case documentation must be presented together with proof of purchase, datasheets, <b>calculations</b>, proof of correct installation and other <b>necessarydocumentation</b> needed to prove their compliance.</li> <li>- Ask for calculations that justify the design's safety.</li> </ul>	T2.5.2 T2.5.3		

184	<ul style="list-style-type: none"> <li>The assembly must be <b>positively locked</b> and be a <b>mechanical connection</b> (green example).</li> <li>Wheel studs may <b>not</b> be fastened/locked by <b>friction</b> only, e.g. a press fit (red example).</li> <li><b>Threaded studs</b> are allowed as long as it is <b>positively locked</b>.</li> <li>Off-the-self conical nuts as well as conical lug nut bolts are allowed if the correct pretension values are used.</li> </ul>  <p>Figure 2 Schematic of studs</p>			
185	<p><b>SUSPENSION (EV - CHECK WITH E STICKERS AND ACCUMULATOR INSIDE)</b> (Checked also in M1 with driver inside)</p> <ul style="list-style-type: none"> <li>The vehicle must be equipped with fully operational front and rear suspension systems including shock absorbers and a usable wheel travel of at least 50mm and a minimum jounce of 25mm <b>with driver seated</b>.</li> <li>All suspension pickup points must be secure and rigid</li> </ul>	T2.4.1		

**STEERING SYSTEM (T6) (VEHICLE ON THE GROUND)**

No.	Checkpoint	Rule No	Checkbox	Comments
186	<ul style="list-style-type: none"> <li>Steering systems using cables or belts for actuation are prohibited. This does not apply for autonomous steering actuators.</li> </ul>	T2.7.1		
187	<ul style="list-style-type: none"> <li>Rear wheels steering maximum 6 degrees and with mechanical stops</li> </ul>	T2.7.11		
188	<ul style="list-style-type: none"> <li>If adjustable tie-rod ends are used, a jam nut must be used to prevent loosening</li> <li>Purchased devices that mechanically prevent loosening are allowed after being thoroughly inspected.</li> </ul>	T10.2.6		

**STEERING WHEEL**

189	<ul style="list-style-type: none"> <li>Steering wheel must be round, oval or near-oval with a quick release installed. No concave sections ! <i>(Check quick release)</i></li> </ul>	T2.7.5 T2.7.7		
190	<ul style="list-style-type: none"> <li>The steering wheel must be no more than 250 mm rearward of the front hoop. This distance is measured horizontally, on the vehicle centerline, from the rear surface of the front hoop to the forward most surface of the steering wheel with the steering in any position.</li> <li>In any angular position, the top of the steering wheel must be no higher than the top-most surface of the front hoop.</li> </ul>	T2.7.6 T2.7.8		
191	<ul style="list-style-type: none"> <li>Assess the steering wheel's structural integrity by pushing it (from the handles) forwards to simulate braking situation and backwards to simulate acceleration forces</li> </ul>			

**STEERING SYSTEM FREE PLAY**

192	<ul style="list-style-type: none"> <li>Allowable <b>steering system free play</b> is limited to a total of 7° measured at the steering wheel. <i>- Position your foot against the wheel and slowly steer. Assess the force on your foot and the steering play existing.</i></li> </ul>	T2.7.4		
193	<ul style="list-style-type: none"> <li>Check for <b>CONTACT</b> between components in the wheel assembly <i>(If in doubt, inspect again with the vehicle lifted and the wheels on)</i></li> </ul>			

194	FRONT LEFT			
195	FRONT RIGHT			
<b>BRAKE SYSTEM</b>				
No.	Checkpoint	Rule No	Checkbox	Comments
196	• No "Brake-by-wire" in manual mode.	T6.1.5		
197	• Hydraulic brake system that acts on all four wheels and is operated by a single control.	T6.1.1		
198	• Two independent hydraulic circuits. In case of leak or failure effective braking power maintained in on at least two wheels	T6.1.2		
199	• A single brake acting on a limited-slip differential is acceptable	T6.1.4		
200	• Sealed to prevent leakage • Unarmored plastic brake lines are prohibited.	T6.1.3 T6.1.6		
201	• The brake system must be <b>protected from failure of the drivetrain</b> , see T 7.3.2, from touching any movable part and from minor collisions. <i>(rotating parts - gears, clutches, chains, belts etc must be fitted with scatter shield. Check protection of brae system)</i>	T6.1.7		
202	• No part of the braking system on the sprung part of the vehicle below the lower surface of the chassis	T6.1.8		
<b>VEHICLE LIFTED AND WHEELS REMOVED</b>				
<b>!WHILE THE VEHICLE IS LIFTED, PERFORM CHECKS WHILE KEEPING ANY BODY PART OUTSIDE OF THE VEHICLE'S FOOTPRINT!</b>				
No.	Checkpoint	Rule No	Checkbox	Comments
	<i>Guidelines</i> - Ask the teams to loosen the wheel nuts to jack the car up. - Check for the proper position of the jacking device (use the points indicated by orange triangles if safe) - Ask the team to remove the wheels			
203	<b>STEERING SYSTEM STOPS</b> • Must have positive steering stops that prevent the steering linkages from locking up. The stops must be placed on the rack and must prevent the tires and rims from contacting any other parts. <b>Steering actuation must be possible during standstill.</b> <i>(Check for collisions in the wheel assembly)</i>	T2.7.3		
<b>FASTENERS (T10)</b>				
No.	Checkpoint	Rule No	Checkbox	Comments
204	<b>LOCKING:</b> The following fasteners are considered <b>critical</b> and have to be <b>positively locked</b> according to T10.2: • <b>Steering System</b> • <b>Braking system (Pedalbox)</b> • <b>Suspension System</b> • <b>ETC</b> • Primary Structure (M2) • Drivers harness (M2) • Accumulator Container (M2)	10.1.1 T 10.2.1		
<b>FRONT LEFT</b>				
205	<b>A-ARMS and A-ARM MOUNTS</b>			
206	• 2 threads minimum	T 10.2.4		
207	• Positive locking	T 10.2.1		
208	• No nylon locknuts in areas with heatsource (max 80 °C)	T 10.2.2		
209	• Check if the bolts are tight			
210	<b>TIE ROD AND TIE ROD LENGTH ADJUSTING SYSTEM</b>			



211	• 2 threads minimum	T 10.2.4		
212	• Positive locking	T 10.2.1		
213	• No nylon locknuts in areas with heatsource (max 80 °C)	T 10.2.2		
214	• Check if the bolts are tight			
215	<b>PUSH/PULL ROD AND LENGTH ADJUSTING SYSTEM</b>			
216	• 2 threads minimum	T 10.2.4		
217	• Positive locking	T 10.2.1		
218	• No nylon locknuts in areas with heatsource (max 80 °C)	T 10.2.2		
219	• Check if the bolts are tight			
220	<b>BRAKE CALIPERS</b>			
221	• 2 threads minimum	T 10.2.4		
222	• Positive locking	T 10.2.1		
223	• No nylon locknuts in areas with heatsource (max 80 °C)	T 10.2.2		
224	• Check if the bolts are tight			
225	<b>BRAKE DISKS</b>			
226	• 2 threads minimum	T 10.2.4		
227	• Positive locking	T 10.2.1		
228	• No nylon locknuts in areas with heatsource (max 80 °C)	T 10.2.2		
229	• Check if the bolts are tight			
<b>FRONT RIGHT</b>				
230	<b>A-ARMS and A-ARM MOUNTS</b>			
231	• 2 threads minimum	T 10.2.4		
232	• Positive locking	T 10.2.1		
233	• No nylon locknuts in areas with heatsource (max 80 °C)	T 10.2.2		
234	• Check if the bolts are tight			
235	<b>TIE ROD AND TIE ROD LENGTH ADJUSTING SYSTEM</b>			
236	• 2 threads minimum	T 10.2.4		
237	• Positive locking	T 10.2.1		
238	• No nylon locknuts in areas with heatsource (max 80 °C)	T 10.2.2		
239	• Check if the bolts are tight			
240	<b>PUSH/PULL ROD AND LENGTH ADJUSTING SYSTEM</b>			
241	• 2 threads minimum	T 10.2.4		
242	• Positive locking	T 10.2.1		
243	• No nylon locknuts in areas with heatsource (max 80 °C)	T 10.2.2		
244	• Check if the bolts are tight			
245	<b>BRAKE CALIPERS</b>			
246	• 2 threads minimum	T 10.2.4		
247	• Positive locking	T 10.2.1		
248	• No nylon locknuts in areas with heatsource (max 80 °C)	T 10.2.2		
249	• Check if the bolts are tight			

250	<b>BRAKE DISKS</b>			
251	• 2 threads minimum	T 10.2.4		
252	• Positive locking	T 10.2.1		
253	• No nylon locknuts in areas with heatsource (max 80 °C)	T 10.2.2		
254	• Check if the bolts are tight			
<b>REAR LEFT</b>				
255	<b>A-ARMS and A-ARM MOUNTS</b>			
256	• 2 threads minimum	T 10.2.4		
257	• Positive locking	T 10.2.1		
258	• No nylon locknuts in areas with heatsource (max 80 °C)	T 10.2.2		
259	• Check if the bolts are tight			
260	<b>TOE LINK AND TOE LINK LENGTH ADJUSTING SYSTEM</b>			
261	• 2 threads minimum	T 10.2.4		
262	• Positive locking	T 10.2.1		
263	• No nylon locknuts in areas with heatsource (max 80 °C)	T 10.2.2		
264	• Check if the bolts are tight			
265	<b>PUSH/PULL RODS AND THEIR LENGTH ADJUSTING SYSTEM</b>			
266	• 2 threads minimum	T 10.2.4		
267	• Positive locking	T 10.2.1		
268	• No nylon locknuts in areas with heatsource (max 80 °C)	T 10.2.2		
269	• Check if the bolts are tight			
270	<b>BRAKE CALIPERS</b>			
271	• 2 threads minimum	T 10.2.4		
272	• Positive locking	T 10.2.1		
273	• No nylon locknuts in areas with heatsource (max 80 °C)	T 10.2.2		
274	• Check if the bolts are tight			
275	<b>BRAKE DISKS</b>			
276	• 2 threads minimum	T 10.2.4		
277	• Positive locking	T 10.2.1		
278	• No nylon locknuts in areas with heatsource (max 80 °C)	T 10.2.2		
279	• Check if the bolts are tight			
<b>REAR RIGHT</b>				
280	<b>A-ARMS and A-ARM MOUNTS</b>			
281	• 2 threads minimum	T 10.2.4		
282	• Positive locking	T 10.2.1		
283	• No nylon locknuts in areas with heatsource (max 80 °C)	T 10.2.2		
284	• Check if the bolts are tight			
285	<b>TOE LINK AND TOE LINK LENGTH ADJUSTING SYSTEM</b>			
286	• 2 threads minimum	T 10.2.4		
287	• Positive locking	T 10.2.1		

288	• No nylon locknuts in areas with heatsource (max 80 °C)	T 10.2.2		
289	• Check if the bolts are tight			
290	<b>PUSH/PULL RODS AND THEIR LENGTH ADJUSTING SYSTEM</b>			
291	• 2 threads minimum	T 10.2.4		
292	• Positive locking	T 10.2.1		
293	• No nylon locknuts in areas with heatsource (max 80 °C)	T 10.2.2		
294	• Check if the bolts are tight			
295	<b>BRAKE CALIPERS</b>			
296	• 2 threads minimum	T 10.2.4		
297	• Positive locking	T 10.2.1		
298	• No nylon locknuts in areas with heatsource (max 80 °C)	T 10.2.2		
299	• Check if the bolts are tight			
300	<b>BRAKE DISKS</b>			
301	• 2 threads minimum	T 10.2.4		
302	• Positive locking	T 10.2.1		
303	• No nylon locknuts in areas with heatsource (max 80 °C)	T 10.2.2		
304	• Check if the bolts are tight			
305	<b>DIFFERENTIAL MOUNT</b>			
306	• 2 threads minimum	T 10.2.4		
307	• Positive locking	T 10.2.1		
308	• No nylon locknuts in areas with heatsource (max 80 °C)	T 10.2.2		
309	• Check if the bolts are tight			
310	<b>WHEEL-MOTOR-GEARBOX ASSEMBLY</b> <ul style="list-style-type: none"> <li>• The teams should provide a 2D cross section of the assembly and explain the design. The individual components (motor mount, bearing installation, planetary gear box installation etc.) shall be properly locked and consist a safe design</li> <li>• Check to the possible extend, if the presented design matches the installation on the car</li> </ul>			
<b>STEERING SYSTEM</b>				
311	• 2 threads minimum	T 10.2.4		
312	• Positive locking	T 10.2.1		
313	• No nylon locknuts in areas with heatsource (max 80 °C)	T 10.2.2		
314	• Check if the bolts are tight			
315	• The teams should provide a 2D cross section of the steering system assembly and explain the design. The individual components, transfer of movement to the wheels, upper and lower steering column bearing mount system should be checked			
316	<b>STEERING RACK</b> <ul style="list-style-type: none"> <li>• must be mechanically attached to the primary structure.</li> <li>• Joints between all components attaching the steering wheel to the steering rack must be mechanical and visible at technical inspection. Bonded joints are allowed in accordance with T 3.2.8.</li> </ul>	T2.7.9		
<b>BRAKE SYSTEM</b>				
No.	Checkpoint	Rule No	Checkbox	Comments
317	• The brake pedal must be fabricated from steel or aluminium or machined from steel, aluminium or titanium.	T6.1.10		

318	<ul style="list-style-type: none"> <li>Repeat check on safety wiring of the braking assembly on each wheel</li> </ul>			
319	<ul style="list-style-type: none"> <li>The <b>brake pedal and its mounting</b> must be designed to withstand a force of <b>2 kN without any failure of the brake system or pedal box</b>. This may be tested by pressing the pedal with the maximum force that can be exerted by any official when seated normally</li> <li><i>The team must provide calculations that all the individual components as mentioned above (brake pedal, brake pedal mounting, pedal box mounting) can withstand a 2 kN force.</i></li> </ul>	T6.1.9		
<b>VEHICLE ASSEMBLED AND ON THE GROUND</b>				
No.	Checkpoint	Rule No	Checkbox	Comments
320	<b>BRAKE PEDAL TEST</b> <ul style="list-style-type: none"> <li>Enter the vehicle and kick the brake pedal</li> <li>Also apply force progressively and slowly to feel any abnormal flexing.</li> </ul>	T6.1.9		
321	<b>STEERING SYSTEM CHECK</b> <ul style="list-style-type: none"> <li>The steering wheel must directly mechanically actuate the front wheels.</li> <li>Steering actuation must be possible during standstill.</li> <li><i>- While inside the vehicle, quickly steer the wheels to check including your weight</i></li> </ul>	T7.2.2 T2.7.3		
<b>APPROVAL STATUS</b>			<a href="#">gid=0</a>	
MECH 4	Approval (Control box) (DON'T CHANGE MANUALLY)		ONWAAR	